

DC-9105E

Conventional Reflective Beam Detector



Description

DC-9105E is a conventional reflective beam detector, powered by 24V. with excellent built-in microprocessor, the detector can carry out system adjustment, drift compensation of ambient data, and judgment of fire and fault through fixed algorithm. The detector has an integral visible laser pointer and 2 bits digital tube. It is easy to install and align with the reflector, convenient for commissioning with indications of 2 bits digital tube displaying received light intensity. The sensitivity of the detector can be set through handheld programmer in field, suitable for various applications including large storage zones, shopping malls, fitness centers, gyms, exhibition halls, hotel lobbies and areas with complex ceilings.

Features and Benefits

- 24V powered.
- Wide operating voltage range, large monitoring areas.
- Combination of the emitting and receiving part makes mounting easy and optical pathway accurate.
- Built-in microprocessor enables intelligent judgment about fire alarm and fault.
- Easy alignment and commissioning via supporting of onboard laser pointer and digital signal intensity indication.
- Self-diagnostic function can monitor the internal fault.
- Drift compensation for factors changing, such as a certain of dust accumulation, positional excursion, and ageing transmitter.
- Onboard N/O fire output and N/C fault dry contact output.
- Four sensitivity levels can be set in field.

Structure and Operation Principle

1) Appearance of the detector is shown in Fig.1.

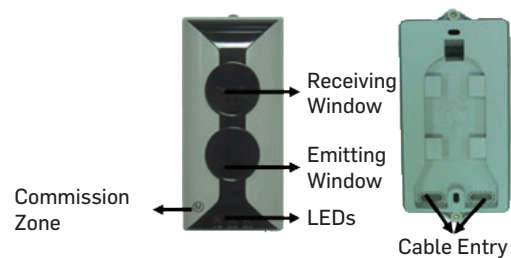

Fig.1

2) Components inside the detector and positions with glue are shown in Fig. 2.

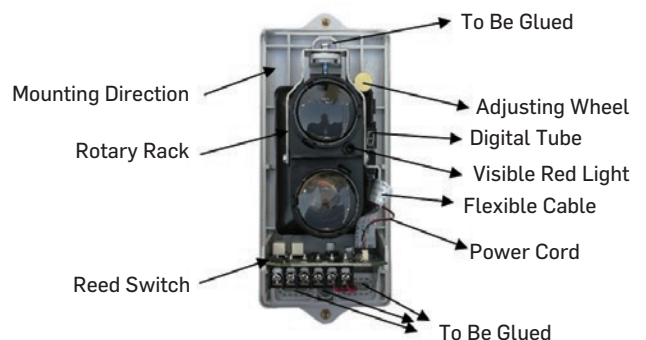

Fig.2

Installation and Terminals

1) Ambient Conditions

The detector monitors and gives alarms by attenuation changes. So, constant or causal obscuration should not appear in the optical beam path.

The wall should be solid and flat to mount a detector or a reflector. The detector is mounted vertically to the wall. Even if the wall looks like flat, it may be uneven or become corrugated due to weather changes. Therefore, the installer should ensure that those factors can't have an impact on the wall for detectors. In addition, the metal rack is used for mounting detectors should be fixed without any vibration.

Not Fit for Locations Where,

The ceiling is higher than 40m.

- It is not roofed.
- The ceiling is lower than 1.5m.
- There is much dust, powder or vapor.
- It generates a lot of dust in some certain conditions even though it is clean in normal state.
- The places are very hot. Note: The air temperature in the transparent ceiling will exceed 55°C while the sun is shining.
- Places are not maintained.
- The wall or bracket for mounting the detector is not stable due to nearby mechanical vibration.
- There are fixed or moving objects obscured within 1m of the optical beam path.
- The strong magnetic field exists.

2) Mounting Height and Position

The height for mounting a detector and reflector/s should be depended on whether smoke enters the optical beam path directly and quickly. Here are some references below.

a) As the space height is not over 5m, the detector and reflector/s should be mounted on the walls which are opposite, having about 0.5m from the ceiling. Refer to Fig. 3.

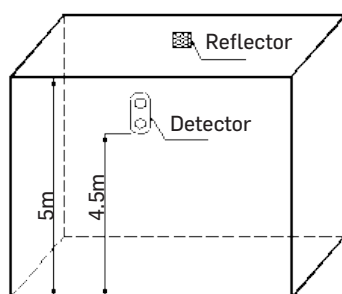

Fig.3

b) As the space height is between 5m and 8m, the detector and reflector/s should be mounted on the walls which are opposite, having about from 0.5m to 1m from the ceiling. Refer to Fig. 4.

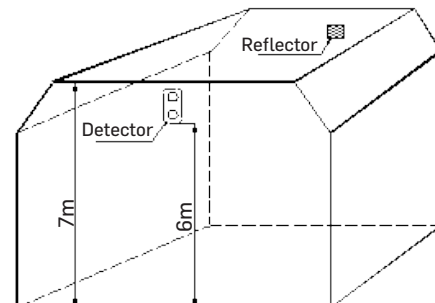

Fig.4

c) As the space height is over 8m, the roof is normally gabled, without ceiling. In this case, the detector and reflector/s should be mounted on the walls which are opposite, having about 7m from the floor and over 0.5m from the top. Refer to Fig. 5.

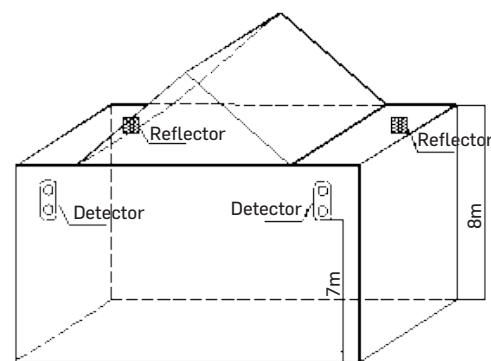

Fig.5

d) As the space height with gable structure is about 8m, the detector and reflector/s should be mounted on the walls which are opposite, having about 1.5m from the gabled girder. Refer to Fig. 6.

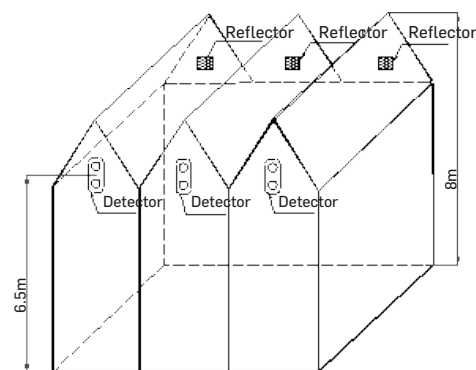

Fig.6

e) The detector should be installed on the south wall of the building surrounded with glass and plastics. However, the detector should be placed on the west wall when north-south installation doesn't work. A sunshade should be equipped with the optical beam path for those applications where reflected sunlight can shine on the detector. Besides, technical engineers in our company can provide better solutions.

3) Installation

a) Optical Path Length

The optical path length of this detector should be set according to applications before installation. It can be set through length types.

Mounting Distance	Length Type
5~20m	20
20~40m	40
40~70m	70
70~100m	100(factory default)

The detector can be set according to mounting distance with four different optical path lengths.

b) Detector Mounting

The detector and reflector/s should be installed on two walls oppositely and horizontally. Refer to Fig.7.

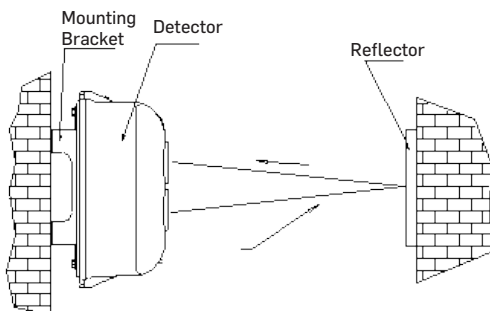

Fig.7

The detector is surface-mounted with conduit embedded or conduit surface-mounted.

(1) Conduit Embedded

- Remove the detector's top cover.
- Aligning the detector base with the back box, put it close to the wall and make marks on the wall for mounting holes.
- Drill holes on the marks and place $\varnothing 6$ plastic expansion bolts in the holes.
- The wire putting through the cable entry should be convenient for wiring.

- The detector base should be fixed to the wall using two plastic expansion bolts and two plain washers. The mounting of the detector is shown in Fig.8.

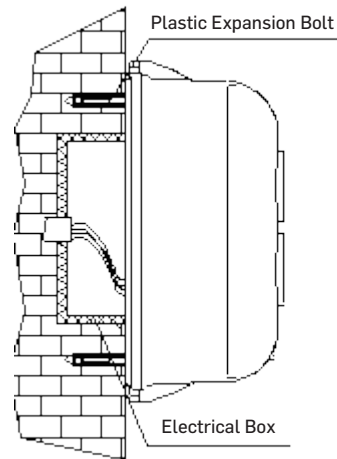

Fig.8

(2) Conduit Surface-mounted

- Put the mounting bracket close to the wall for the detector, make marks for mounting holes.
- Drill holes on the marks and place $\varnothing 6$ plastic expansion bolts in the holes.
- The bracket should be fixed to the wall using four plastic expansion bolts and four plain washers.
- The wire putting through the cable entry after removing the detector top cover should be convenient for wiring.
- The detector base should be fixed to the mounting bracket using two M4 \times 10 screws and two plain washers.
- The mounting bracket should be earthed through a mounting hole.

The mounting of the detector is shown in Fig.9.

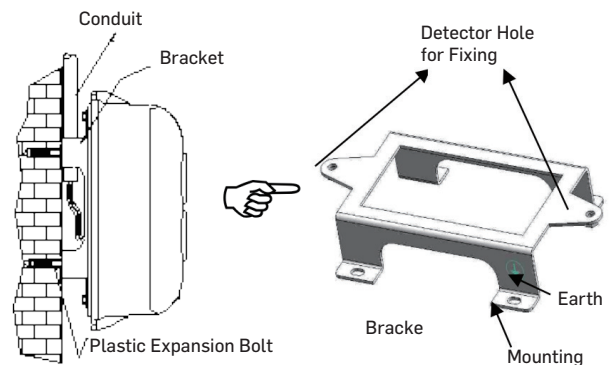

Fig.9

a) Mounting Reflector:

Reflector should be mounted on the position keeping the same level with the detector but opposite to it. One reflector is required as the distance from the detector to the reflector is between 5m and 40m, when the actual distance installation between the detector and the reflector is less than 10 meters, it is needed to paste the non-reflective mask on the reflector because the infrared light reflected by the reflector is too strong; four reflectors are needed as the distance from the detector to the reflector is between 40m and 100m. Two $\varnothing 6$ plastic expansion bolts are used to fix one reflector. Refer to Fig. 10a for details. Four reflectors should be placed seamlessly when mounted. Refer to Fig.10b for details. The non-reflective mask refers to Fig.10c.

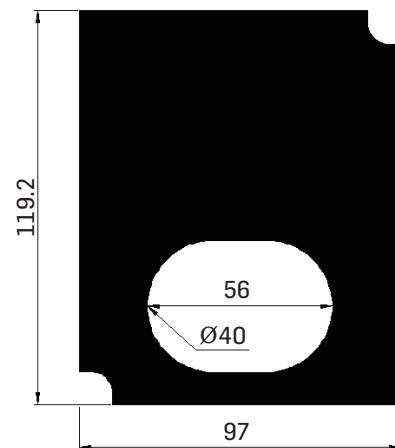

Fig.10c(unit: mm)

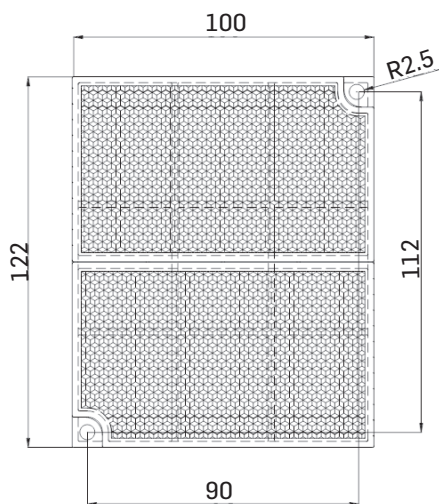

Fig.10a(unit: mm)

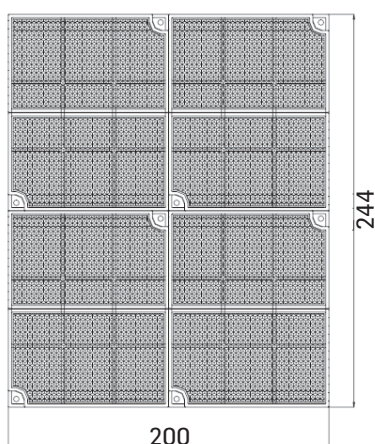

Fig.10b(unit: mm)

a) Recommended Wiring

In field, D1, D2 (polarity insensitive) of a detector should be connected to 24VDC power line. The reflector doesn't need any wires. K11 and K12 are fire output contacts. K21 and K22 are fault output contacts. The terminals of the detector are shown in Fig.11.

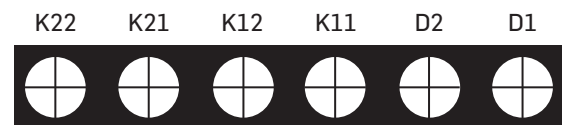

Fig.11

Wiring: 1.5mm² or above fire cable for D1, D2. 1.0mm² or above twisted pair for K11, K12, K21 and K22. 1.0mm² or above for the grounding wire.

Note: As the detector is mounted in the special environment such as dust, damp, three positions as shown in Fig. 2 should be sealed with glass glue or 703 silica gel after fixing and wiring, ensuring the detector works stably.

Certificates and Compliance

- Standards: EN 54-12: 2015
- Certifications: LPCB

Technical Specification

Operating Voltage	DC 24V (18V~28V)
Commission current	≤20mA
Standby current	≤12mA
Alarm current	≤22mA
Angle of Adjusting	-6° ~ +6°
Maximum angular misalignment	±0.5°
Sensitivity Level	Level 1: 1.3dB Level 2: 1.8dB (factory default) Level 3: 2.3dB Level 4: 2.8dB (not EN 54-12: 2015 approved)
Operating Environment	Temperature: -10C ~ +50C Relative Humidity ≤95%, non condensing
Length of Optical Pathway	5m~100m
Monitoring Area	Maximum monitoring area: 14 x100 =1400m ² Maximum width: 14m
Material and Color of Enclosure	ABS, Gray
Dimensions	206mm X 95mm X 95mm
Ingress Protection Rating	IP20 without glue-seal IP66 through glue-seal treatment
Weight	450g

Accessories and Tools



Part No.: RF-9105R Reflector
Device Name: Reflector
Product No.: 20103590

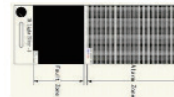

Part No.: IR light filter
Device name: Fire and Fault tester
Product No.: 30202477/30208095

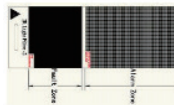

Part No.: Bracket
Device name: Mounting Bracket
Product No.: 30202359



Part No.: Non-reflective mas
Device name: Non-reflective mask
Product No.: 20103775

*Order Separately



Part No.: P-9910B
Device name: Handheld Programmer
Product No.: 10104894

*Order Separately

Ordering Information and Compatible Products

Part No.	DC-9105E
Device Name	Conventional Reflective Beam Detector
Product No.	10106205